

OK  
OL

LAKE  
PARK

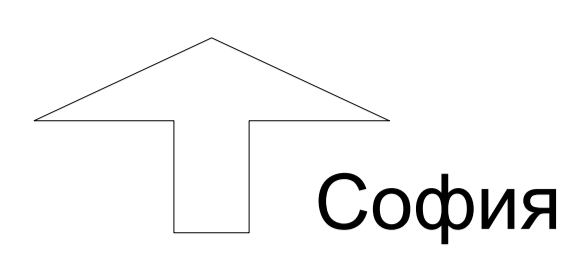

София

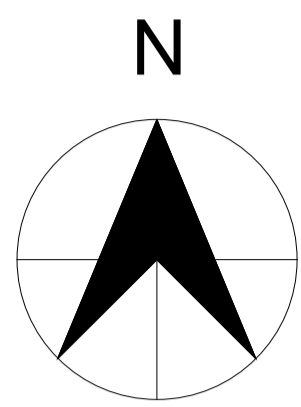

с. Горни Окол

яз. Искър

Самоков

ЛЕГЕНДА / LEGEND:

<ul style="list-style-type: none"> <li>● Едноетажна еднофамилна сграда тип 1/ House type 1 РЗП/ТВА=143,34m<sup>2</sup> ЗП/ВА=143,34m<sup>2</sup></li> <li>● Едноетажна еднофамилна сграда тип 2/ Two-storey house type 2 РЗП/ТВА=295,81m<sup>2</sup> ЗП/ВА=218,42m<sup>2</sup></li> <li>● Едноетажна еднофамилна сграда тип 3/ Two-storey house type 3 РЗП/ТВА=267,82m<sup>2</sup> ЗП/ВА=190,39m<sup>2</sup></li> <li>● Двуетажна еднофамилна сграда тип 4/ Three-storey house type 4 РЗП/ТВА=390,72m<sup>2</sup> ЗП/ВА=150,43m<sup>2</sup></li> <li>● Двуетажна еднофамилна сграда тип 5/ Three-storey house type 5 РЗП/ТВА=352,73m<sup>2</sup> ЗП/ВА=131,96m<sup>2</sup></li> </ul>	<ul style="list-style-type: none"> <li>● Триетажна еднофамилна сграда тип 6/ Three-storey house type 6 РЗП/ТВА=505,68m<sup>2</sup> ЗП/ВА=197,45m<sup>2</sup></li> <li>● Двуетажна еднофамилна сграда тип 7/ Two-storey house type 7 РЗП/ТВА=323m<sup>2</sup> ЗП/ВА=220,85m<sup>2</sup></li> <li>● Едноетажна еднофамилна сграда тип 8/ House type 8 РЗП/ТВА=700m<sup>2</sup> ЗП/ВА=420m<sup>2</sup></li> <li>● Едноетажна еднофамилна сграда тип 9/ House type 9 РЗП/ТВА=285m<sup>2</sup> ЗП/ВА=285m<sup>2</sup></li> </ul>
---	---

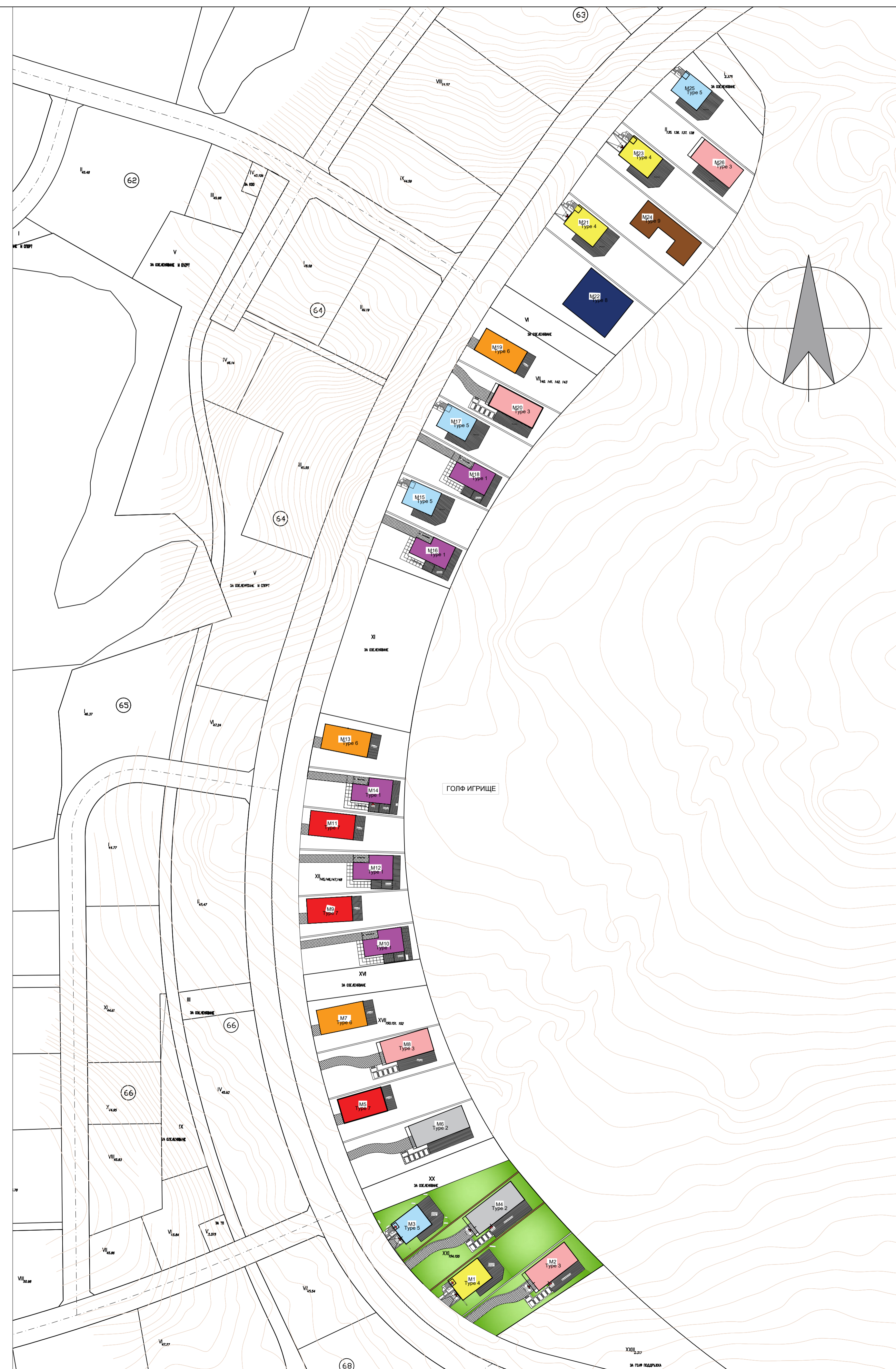

Допустими показатели за парцела

Зона	Ц	
Кота върха (ЖК)	≤10m	
Плътност на застрояване	40%	10   40
Коефициент на интензивност	Кинт=0,6	0,6   40
Минимална озеленена площ	40%	
Свободно застрояване	е	е

**Еднофамилни жилищни сгради**  
УПИ XXI  
УПИ XXI-154.155, кв.67, с. Горни Окол, община Самоков

**Residential buildings**  
UPI XXI  
UPI XXI-154.155, neib.67, Gorni Okol village, Samokov municipality

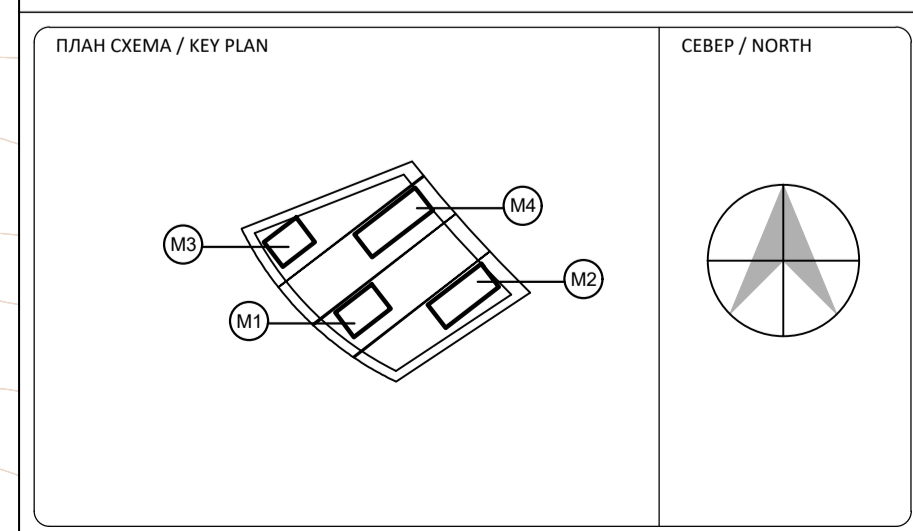

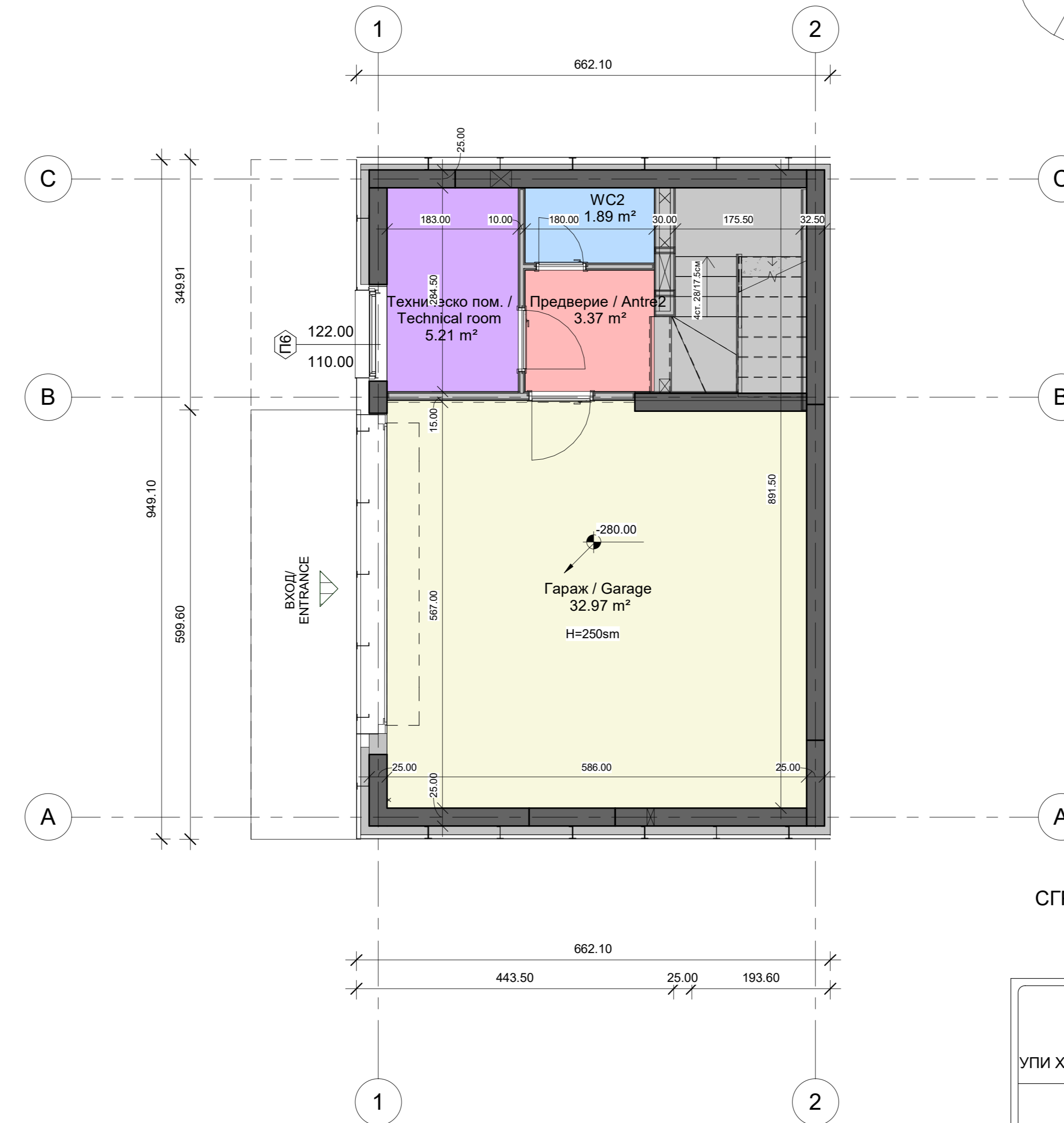
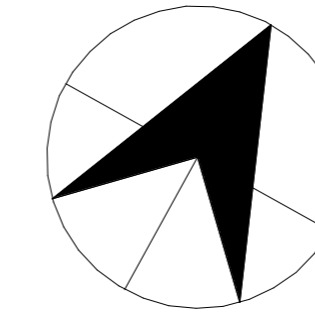

СГРАДА M2 Тип 3 / HOUSE M2 Type 3  
НИВО -2.80m / LEVEL -2.80m  
ЕТАЖ -1 / LEVEL -1

Четири еднофамилни жилищни сгради-  
СГРАДА - M2  
УПИ XXI -154.155, кв. 67, с. Горни Окол, община Самоков  
Residential buildings - House M2  
УПИ XXI - 154.155, кв. 67, Gorni Okol village, Samokov  
municipality

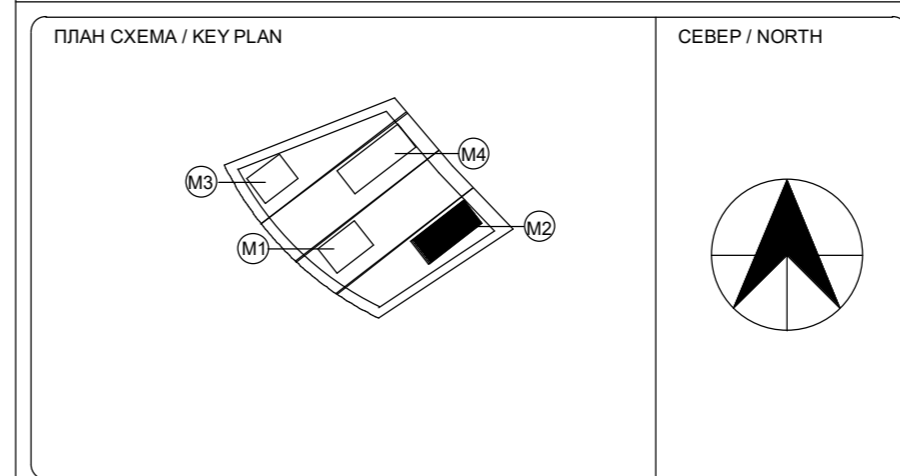

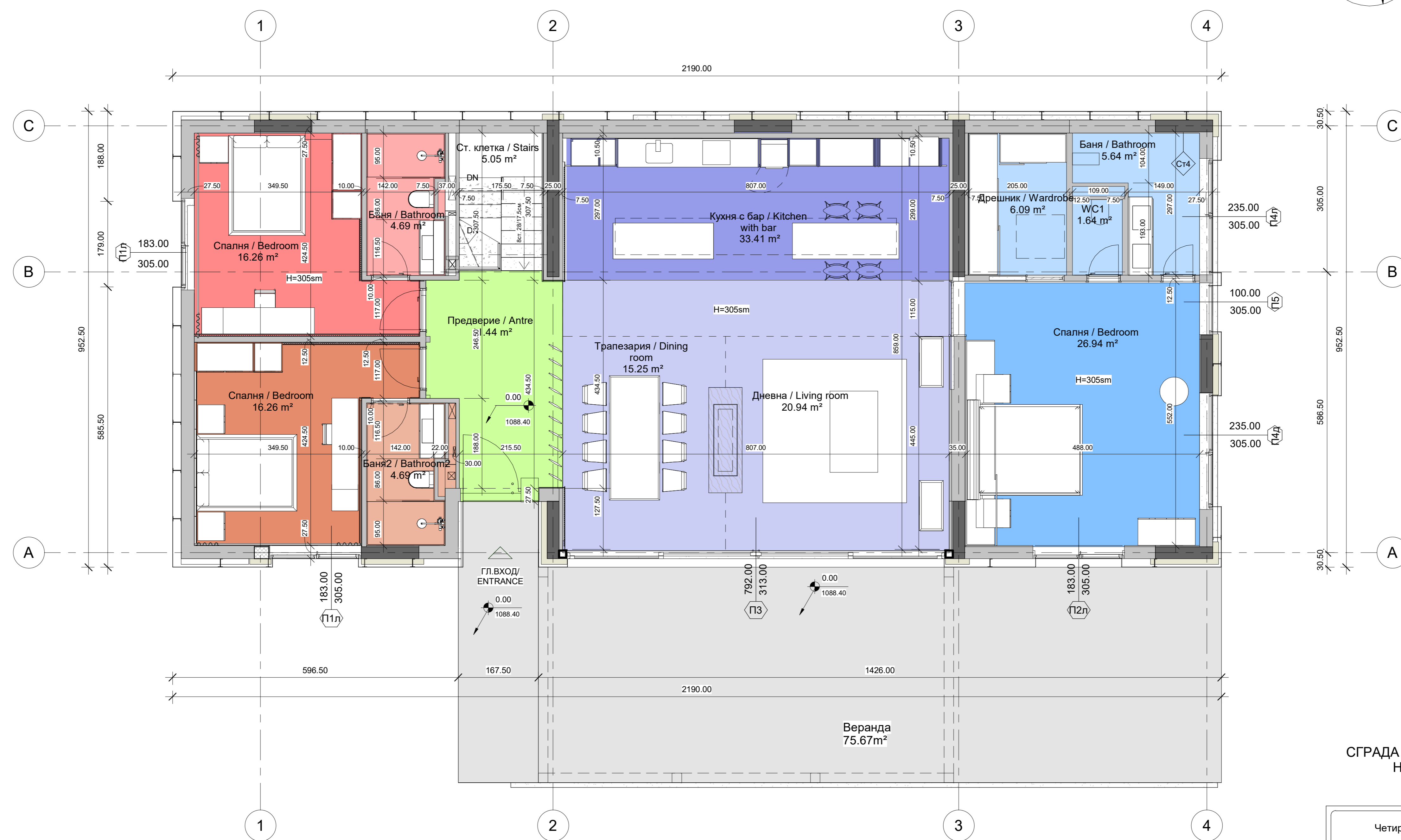

СГРАДА М2 Тип 3/ HOUSE M2 Type 3  
 НИВО ±0.00m / LEVEL ±0.00m  
 ЕТАЖ 1 / LEVEL 1

Четири еднофамилни жилищни сгради-  
 СГРАДА - М2  
 УПИ XXI -154.155, кв.67, с. Горни Окол, община Самоков  
 Residential buildings - House M2  
 УПИ XXI - 154.155, neib. 67, Gorni Okol village, Samokov  
 municipality

ПЛАН СХЕМА / KEY PLAN

СЕБЕР / NORTH